

Serie QUADRA



La serie Quadra mantiene le stesse caratteristiche della serie Idea, fondendo l'utilizzo di pannelli in legno e montanti in alluminio; l'utilizzo di profili più robusti (sezione 30×30 mm) e pannelli di maggior spessore permette però di raggiungere dimensioni superiori (fino al metro di lunghezza). Anch'essa è disponibile nella versione con o senza mobile.

*Quadra series maintains same characteristics as Idea series, merging the **use of wooden panels and aluminum uprights**; Using **bigger aluminium profiles** (section 30 × 30 mm) and **thicker panels**, however, allows to reach larger dimensions (up to one meter in length). Available with or without cabinet.*



Caratteristiche generali | General features

Telaio in alluminio sezione quadrata

Square section aluminum frame

Vetri temperati

All tempered glasses

Guarnizioni antipolvere nascoste

Hidden dust seals

Top e fondo / mobile di base in laminato

Laminated wood top and base/cupboard

Ante a libro con serratura

Turning doors with lock

Ripiani interni regolabili in altezza

Internal adjustable shelves

Base con ruote o piedini

Base with wheels or feet

Finiture standard | Standard colours

Finiture standard sempre disponibili a magazzino:

Standard finishes, always available in stock



Alluminio anodizzato | *Anodised aluminium*



Alluminio nero | *Black aluminium*



Pannelli laminato grigio | *Grey laminated wood*



Pannelli laminato nero | *Black laminated wood*

A richiesta è possibile realizzare ogni modello con finiture diverse, sia per le parti in alluminio (**verniciature a polvere / trattamenti superficiali**) che per le parti in laminato (**tinte legno o piatte**); per maggiori informazioni fare riferimento alla pagina web dedicata.

*On request we can realize every our model with different features, both for aluminium parts (**dust laquering or surface treatments**) and for wooden parts (**full colours or wood finishing**); for more info refer to our dedicated web page.*

Illuminazione interna | Internal lighting system



Illuminazione interna con faretti orientabili mediante elettrificazione dei montanti verticali. Braccetti telescopici, bulbo orientabile in verticale ed orizzontale. Posizionamento sotto il ripiano, su un lato o su entrambi i lati – attacco MR 16, diametro 35mm o 50mm. Colore bianco neutro 4000/4500 K (a richiesta bianco caldo o freddo).

Internal lighting system with adjustable spotlights by electrification of vertical uprights. Telescopic brackets, vertically and horizontally adjustable bulb. Placed under shelf, on one or both sides - connection MR 16, diameter 35mm or 50mm. Neutral white color 4000/4500 K (warm or cold white on request).

Strisce LED ad alta efficienza.

Installazione di strisce LED inserite nei due montanti verticali (lato antina o a rischio lato schienale). Alimentazione a 12V con trasformatore elettronico. Colore standard della luce: bianco neutro 4000/4500 K (a richiesta disponibili bianco freddo o bianco caldo)

High efficiency LED strips.

Installation of LED strips inserted in the two vertical uprights (front door or on back side on request). 12V power supply with electronic transformer. Standard light color: neutral white 4000/4500 K (cold white or warm white available on request)



Personalizzazioni aggiuntive | *Extra options*



Ripiani aggiuntivi /
Extra shelves



Ante in vetro scorrevoli con o senza serratura /
Sliding glass doors with or without lock



Zoccolo di copertura alla base /
Wood socle base cover



Schienale in laminato /
Wood backing

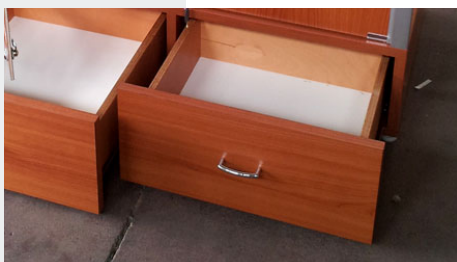

Mobile di base con cassetiera /
Cabinet base with drawers

E' possibile realizzare inoltre ulteriori personalizzazioni ad hoc su specifiche progettuali del cliente.
Personal customization designed and realized on customer project available.

Dimensioni standard / Standard sizes

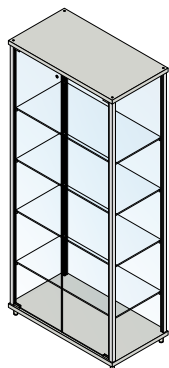
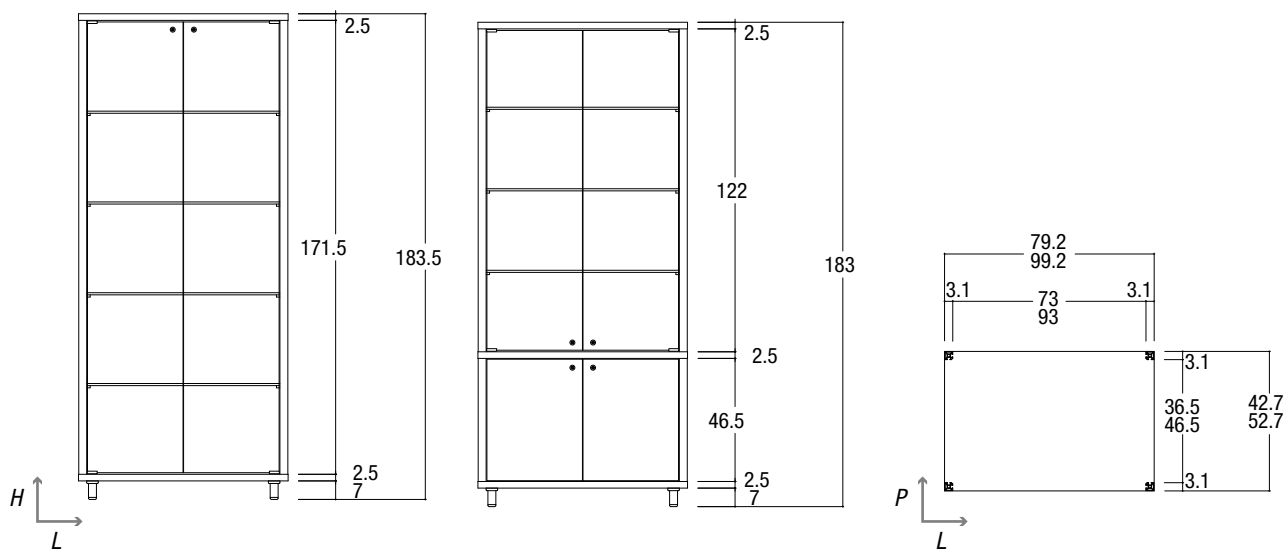

Cod. QV-79-43
cm 79.2 x 42.7 x 183.5 h

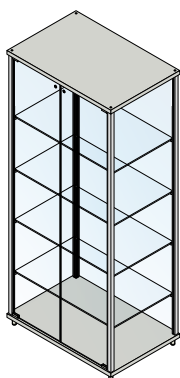

Cod. QV-79-53
cm 79.2 x 52.7 x 183.5 h

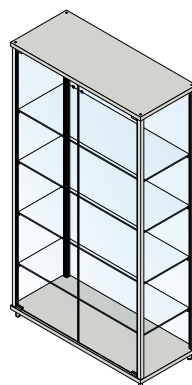

Cod. QV-99-43
cm 99.2 x 42.7 x 183.5 h

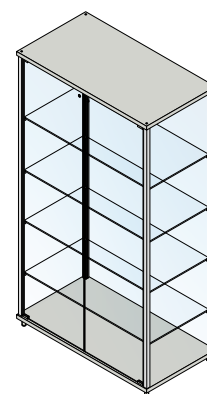

Cod. QV-99-53
cm 99.2 x 52.7 x 183.5 h

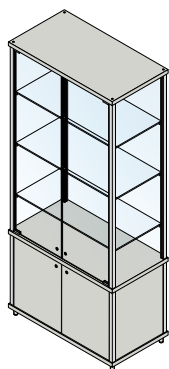

Cod. QM-79-43
cm 79.2 x 42.7 x 183 h

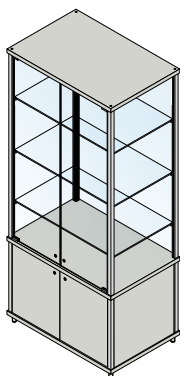

Cod. QM-79-53
cm 79.2 x 52.7 x 183 h

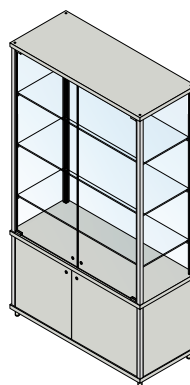

Cod. QM-99-43
cm 99.2 x 42.7 x 183 h

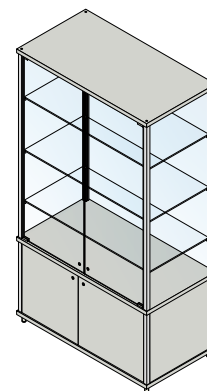

Cod. QM-99-53
cm 99.2 x 52.7 x 183 h